

Cal. 6M25, 6M26

INSTRUCTIONS	(P. 3)
INSTRUCTIONS	(P. 30)
INSTRUCCIONES	(P. 58)
BEDIENUNGSANLEITUNG	(S. 86)
ISTRUZIONI	(P. 114)
INSTRUÇÕES	(P. 143)
用法說明	(171 頁)

You are now the proud owner of a SEIKO Analogue Quartz Watch Cal. 6M25/6M26. For best results, please read the instructions in this booklet carefully before using your SEIKO Analogue Quartz Watch. Please keep this manual handy for ready reference.

Vous voici l'heureux propriétaire d'une montre quartz analogique SEIKO Cal. 6M25/6M26. Pour obtenir d'excellentes performances de cet article SEIKO, veuillez lire attentivement cette brochure que vous conserverez pour toute référence ultérieure.

Enhorabuena por su adquisición de un reloj SEIKO analógico de cuarzo Cal. 6M25/6M26. Para óptimo resultado, lea detenidamente las instrucciones de este folleto antes de usar el reloj. Guarde este manual para consulta posterior.

Sie sind jetzt Besitzer einer SEIKO Analog-Quarzuhr Kal. 6M25/6M26. Bitte lesen Sie diese Bedienungsanleitung vor Verwendung der Uhr sorgfältig durch und heben Sie sie gut auf.

Siete ora in possesso di un orologio SEIKO Analogico al Quarzo Cal. 6M25/6M26. Per ottenere i migliori possibili risultati dal Vostro orologio, leggere attentamente le istruzioni di questo manuale prima di utilizzare il Vostro orologio SEIKO analogico al quarzo. Conservare poi il manuale stesso per ogni qualsiasi eventuale futuro riferimento.

Você pode sentir-se orgulhoso de possuir um Relógio SEIKO Quartz Análogo Cal. 6M25/6M26. Para obter os melhores resultados, leia atentamente as instruções contidas neste opúsculo antes de usar o seu Relógio SEIKO Quartz Análogo. Queira conservar este manual para referências futuras.

6M25/6M26

CONTENTS

	Page
FEATURES	4
MODES AND DISPLAYS	5
ADJUSTING THE HAND AND DATE POSITIONS	7
TIME SETTING	9
CALENDAR	10
ALARM	11
TIMER	13
STOPWATCH	15
TACHYMETER	18
NECESSARY PROCEDURE AFTER BATTERY CHANGE	20
NOTES ON OPERATING THE WATCH	22
BATTERY LIFE INDICATOR	24
BATTERY CHANGE	24
TO PRESERVE THE QUALITY OF YOUR WATCH	26
SPECIFICATIONS	29

SEIKO ANALOGUE QUARTZ

Cal. 6M25, 6M26

FEATURES



TIME

- Hour, minute & second hands



CALENDAR

- Date displayed in numerals
- Month indicated by hands
- Calendar adjusts automatically except February of leap years.



ALARM

- Can be set to ring on a 12-hour basis.



TIMER

- Up to 60 minutes can be set in minute increments.



STOPWATCH

- Measures up to 60 minutes in 1/10 second increments.



TACHYMETER

- For models with tachymeter scale

MODES AND DISPLAYS

There are two buttons and a crown.

[Cal. 6M25]

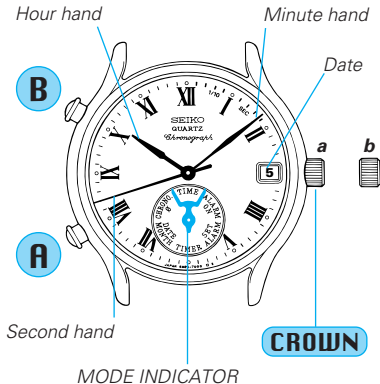

a: Normal position

[Cal. 6M26]

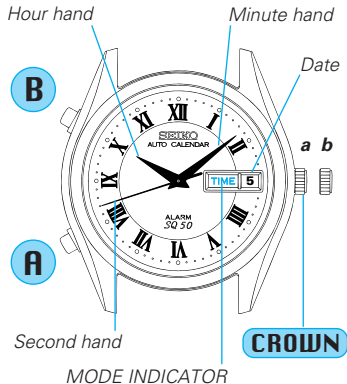

b: Extended position

MODE CHANGE

CROWN

Turn at *normal position* clockwise or counterclockwise.

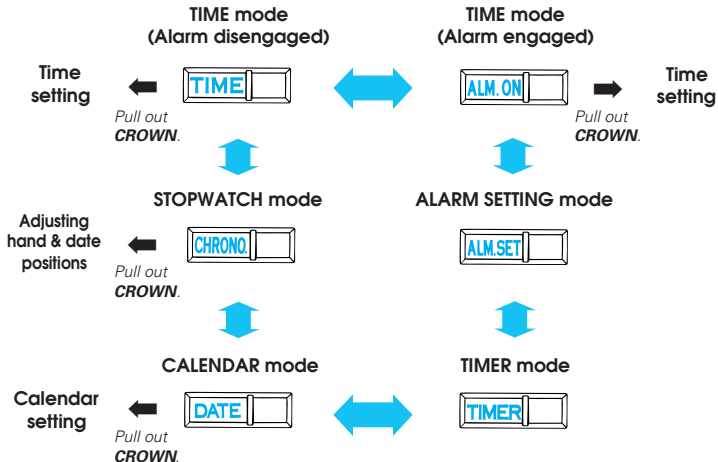

ADJUSTING THE HAND AND DATE POSITIONS

- Before setting the time and calendar, be sure to use STOPWATCH mode to check the positions of Hour, Minute and Second hands and the date numeral.

CROWN Turn to set MODE INDICATOR to "CHRONO.".



** If the stopwatch is counting, first press **Button B** to stop measurement and then press **Button A** to reset the hands.*

HOW TO RESET THE HAND AND DATE POSITIONS

- If the hands do not return to the 12 o'clock position or the date numeral does not appear at the center of the calendar frame, reset them following the procedure below. If they do not need resetting, go on to the next section ("TIME SETTING").

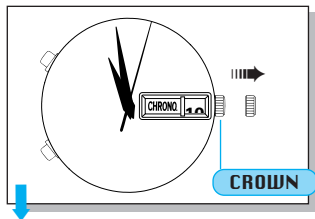

CROWN Pull out.



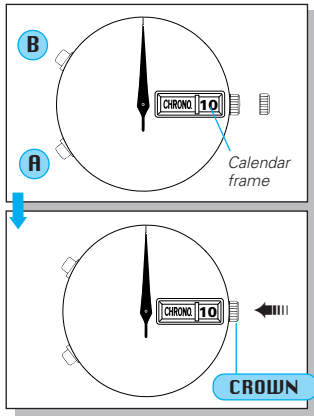

Press to select what is to be adjusted (hands or date) in the following order (See *1 on page 22):

Second hand

Minute hand

Date

Hour hand

Press to reset the selected hand to the 12 o'clock position or put the date to the center of the calendar frame. (See *2 on page 22)

CROWN

Push back in to **normal position**.

TIME SETTING

CROWN

Turn to set MODE INDICATOR to "TIME" or "ALM.ON".

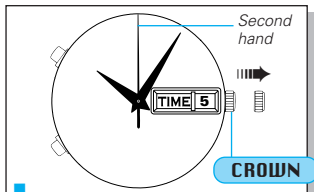

CROWN

Pull out.

** Second hand automatically returns to the 12 o'clock position.*

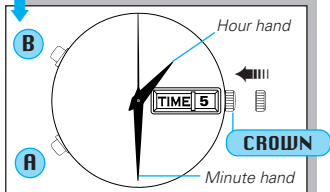

B

Press to set Minute hand. (See *2 and *3 on page 22)

A

Press to set Hour hand. (See *2 and *4 on page 22)

CROWN

Push back in to **normal position** in accordance with a time signal.

CALENDAR

- The month is indicated by the hour marker that all three hands point to.
- The date is indicated by the numeral shown in the calendar frame.
- The calendar automatically adjusts for odd and even months except February of leap years.

CROWN

Turn to set MODE INDICATOR to "DATE".



CALENDAR SETTING

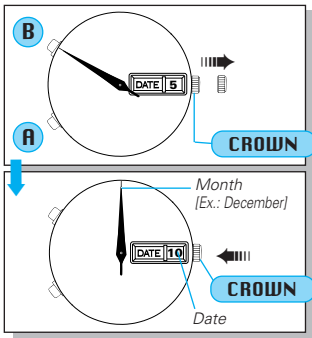

CROWN

Pull out.

B

Press to set the month (Ex. December). (See *2 on page 22)

A

Press to set the date (Ex. 10th). (See *2 on page 22)

CROWN

Push back in to **normal position**.

ALARM

- The alarm can be set to ring on a 12-hour basis.

ALARM SETTING

CROWN

Turn to set MODE INDICATOR to "ALM.SET". (See *5 on page 22)

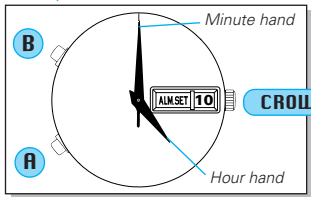

B

Press to set Minute hand. (See *2 and *3 on page 22)

A

Press to set Hour hand. (See *2 on page 22)

CROWN

Turn to set MODE INDICATOR to "ALM.ON" or "TIME" to engage or disengage the alarm. (See the following section)

ALARM ENGAGEMENT/DISENGAGEMENT

• Alarm engagement

CROWN Turn to set MODE INDICATOR to "ALM.ON".
(See also *6 on page 22)

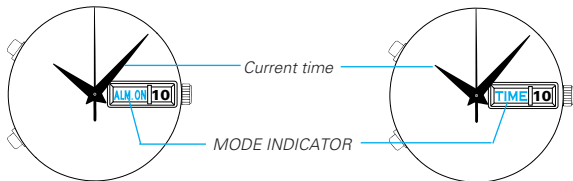

[TIME mode with alarm engaged]

• Alarm disengagement

CROWN Turn to set MODE INDICATOR to "TIME".

[TIME mode with alarm disengaged]

- Alarm rings at the designated time for 20 seconds.
* To stop it manually, press **Button A or B**.
- To check the designated alarm time, set MODE INDICATOR to "ALM.SET".

TIMER

- The timer can be set to count down up to 60 minutes in minute increments.

CROWN

Turn to set MODE INDICATOR to "TIMER".



TIMER SETTING

- Before setting the timer, check that the three hands are at "0" position.

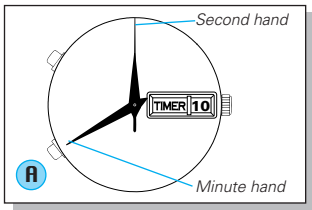

A

Press to set the desired amount of time in minutes. (See *2 on page 22)

** To set the timer for 60 minutes, set Minute hand at "0" position.*

TIMER OPERATION

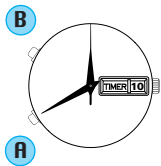

* Restart and stop of timer can be repeated by pressing **Button B**.

● When the set time is up, a warning sound beeps for approximately 5 seconds.

* To stop it manually, press **Button A or B**.

* See also *7 on page 22.

STOPWATCH

- Stopwatch measures up to 60 minutes in 1/10 second increments.

CROWN

Turn to set MODE INDICATOR to "CHRONO.".



- *In the following cases, the stopwatch operations cannot be made:*
 - 1) *While the timer warning sound is beeping (for about 5 seconds).*
 - 2) *While the hands are moving quickly to catch up with the accumulated elapsed time after the split time is released (less than 5 seconds).*
- * *See also *8 on page 23.*

HOW TO READ THE HANDS

- In STOPWATCH mode, each hand indicates the elapsed time as follows:

In other modes		In STOPWATCH mode
Second hand	➔	1/10 seconds
Minute hand	➔	Seconds
Hour hand	➔	Minutes

- **For the first 1 minute**

Ex.: 20 and 7/10 seconds

Minute hand 1/10 second hand*

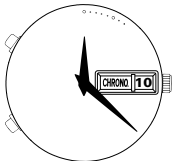

Second hand

- **After the first 1 minute**

Ex.: during measurement

1/10 second hand**

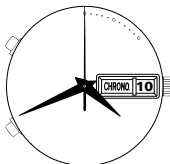

Minute hand

Ex.: when measurement is stopped or split time is measured

1/10 second hand***

Second hand



Minute hand

* 1/10 second hand moves from 0 to 9 (minute markers) repeatedly.

** 1/10 second hand stays at "0" position while the stopwatch is counting.

*** When the measurement is stopped or split time is measured, 1/10 second hand indicates the 1/10 seconds measured.

When the measurement is restarted or split time is released, it returns to "0" position.

TACHYMETER

(for models with tachymeter scale on the dial)

To measure the hourly average speed of a vehicle

- 1 Use the stopwatch to determine how many seconds it takes to go 1 km or 1 mile.
- 2 Tachymeter scale indicated by Second hand gives the average speed per hour.

Ex. 1

Second hand:
40 seconds



Tachymeter scale: "90"

"90" (tachymeter scale figure) x 1 (km or mile)
= 90 km/h or mph

* Tachymeter scale can be used only when the time required is less than 60 seconds.

Ex. 2: If the measuring distance is extended to 2 km or miles or shortened to 0.5 km or miles and Second hand indicates "90" on tachymeter scale:

"90" (tachymeter scale figure) x 2 (km or mile) = 180 km/h or mph

"90" (tachymeter scale figure) x 0.5 (km or mile) = 45 km/h or mph

To measure the hourly rate of operation

- 1 Use the stopwatch to measure the time required to complete 1 job.
- 2 Tachymeter scale indicated by Second hand gives the average number of jobs accomplished per hour.

Ex. 1

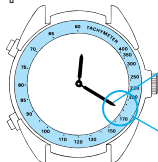

Second hand:
20 seconds

Tachymeter scale:
"180"

"180" (tachymeter scale figure) x 1 job
= 180 jobs/hour

Ex. 2: If 15 jobs are completed in 20 seconds:

"180" (tachymeter scale figure) x 15 jobs = 2700 jobs/hour

NECESSARY PROCEDURE AFTER BATTERY CHANGE

- When the battery is replaced, the information stored in the IC does not correspond with the time and date actually displayed. Before using the watch, therefore, be sure to reset the hands and date, following the procedure below.

CROWN Turn to set MODE INDICATOR to "CHRONO."



** If the stopwatch is counting, first press **Button B** to stop measurement and then press **Button A** to reset the hands.*

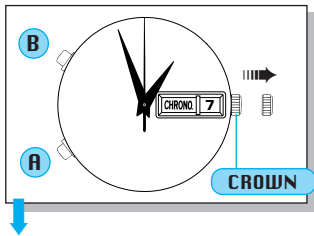

CROWN Pull out.

A AND **B** Press and hold at the same time for 2 seconds.

** A beep sounds when the buttons are released, and the hands start to show demonstration movement.*

A OR **B** Press to stop the hands.

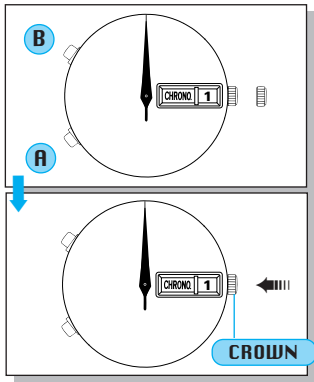

Press to select what is to be adjusted (hands or date) in the following order (See *1 on page 22):

Second hand

Minute hand

Date

Hour hand

Press to reset the selected hand to the 12 o'clock position or set the date to "1". (See *2 on page 22)

CROWN

Push back in to **normal position**.

* After resetting the hands and date as explained above, set the time and calendar. (See "TIME SETTING" and "CALENDAR")

NOTES ON OPERATING THE WATCH

- *1 When a hand is selected, it will move back and forth and return to where it was. When the date is selected, it will advance one day and return to the current date.
- *2 The hand(s)/date move(s) quickly if the corresponding button is kept pressed for 2 seconds.
- *3 As Minute hand moves, Hour hand also moves correspondingly.
- *4 When setting Hour hand, check that AM/PM is correctly set.
 - Press **Button A** to turn Hour hand past the 12 o'clock marker to determine whether the watch is set for the A.M. or P.M. period. If the date changes, the time is set for the A.M. period. If the date does not change, the time is set for the P.M. period.
While the date is changing, Hour hand stops on the 12 o'clock position even if **Button A** is kept pressed.
- *5 The alarm time can be set with the **CROWN** both at the normal position and at the extended position.
- *6 **Alarm test:** With the **CROWN** at "ALM.ON", press and hold **Buttons A and B** at the same time.
- *7 **Remarks on timer operation:**
 - In TIMER mode, Hour hand stops at the 12 o'clock position.
 - With each press of the buttons, a beep sounds for confirmation.
 - Even if the mode is changed from TIMER to another while the timer is counting down, it continues counting. If the timer is stopped, however, the hands will be reset to "0" position by changing the mode.

*8 Remarks on stopwatch operation:

- With each press of the buttons, a beep sounds for confirmation.
- Even if the mode is changed from STOPWATCH to another while the stopwatch is measuring, it continues counting. If the split time is measured, however, it will be released and counting will be continued by changing the mode.

☆☆ Demonstration movement of hands ☆☆

If **Buttons A and B** are pressed at the same time for 2 seconds, Hour and Minute hands turn counter-clockwise and clockwise, respectively, and Second hand moves back and forth at the 12 o'clock position.

- * To stop the demonstration, press **Button A or B**.
- * If the watch is left untouched with the hands showing the demonstration movement, they will automatically return to indicate the current time in about 2 minutes.

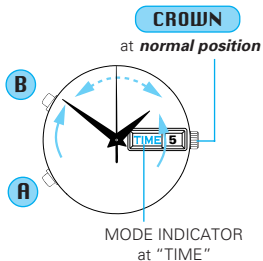

BATTERY LIFE INDICATOR

- The battery needs to be replaced when you see the Second hand moving at two-second intervals instead of normal one-second intervals.

** The watch will, however, remain accurate while Second hand is moving at two-second intervals.*

BATTERY CHANGE

2
Years

The miniature battery which powers your watch should last approximately **2 years**. However, because the battery is inserted at the factory to check the function and performance of the watch, its actual life once in your possession may be less than the specified period. When the battery expires, be sure to replace it as soon as possible to prevent any malfunction. For battery replacement, we recommend that you contact an AUTHORIZED SEIKO DEALER and request **SEIKO SR927W** battery.

** The battery life may be less than 2 years if:*

- *the alarm is used more than once a day,*
- *the timer is used for more than 5 minutes a day, and/or*
- *the stopwatch is used for more than 5 minutes a day.*

**WARNING**

- Do not remove the battery from the watch.
- If it is necessary to take out the battery, keep it out of the reach of children. If a child swallows it, consult a doctor immediately.
- Never short-circuit, tamper with or heat the battery, and never expose it to fire. The battery may burst, become very hot or catch fire.

**CAUTION**

- The battery is not rechargeable. Never attempt to recharge it, as this may cause battery leakage or damage to the battery.

TO PRESERVE THE QUALITY OF YOUR WATCH

■ WATER RESISTANCE

Indication on case back	Condition of use	Accidental contact with water such as rain and splashes	Swimming, yachting and taking a shower	Taking a bath and shallow diving	Scuba diving** and saturation diving
	Degree of water resistance*				
No indication	Non-water resistant	No	No	No	No
WATER RESISTANT	3 bar	Yes	No	No	No
WATER RESISTANT 5 BAR	5 bar	Yes	Yes	No	No
WATER RESISTANT 10/15/20 BAR	10/15/20 bar	Yes	Yes	Yes	No

● Non-water resistant



- If the watch becomes wet, have it checked by an AUTHORIZED SEIKO DEALER or SERVICE CENTER.

● Water resistant 5/10/15/20 bar



- Before using in water, be sure the crown is pushed in completely.
- Do not operate the crown and buttons when the watch is wet or in water.



If used in sea water, rinse the watch in fresh water and dry it completely.

- When taking a shower with a water resistant 5 bar watch, or taking a bath with a water resistant 10, 15 or 20 bar watch, be sure to observe the following:
 - * Do not operate the crown or push the buttons when the watch is wet with soapy water or shampoo.
 - * If the watch is left in warm water, a slight time loss or gain may be caused. This condition, however, will be corrected when the watch returns to normal temperature.

** Pressure in bar is a test pressure and should not be considered as corresponding to actual diving depth since swimming movement tends to increase the pressure at a given depth. Care should also be taken on diving into water.*

*** We recommend that you wear a SEIKO Diver's Watch for scuba diving.*

■ TEMPERATURES



Your watch works with stable accuracy within a temperature range of 5°C and 35°C (41°F and 95°F).

Temperatures over 60°C (140°F) or below -10°C (+14°F) may cause a slight time loss or gain or battery leakage or shorten the battery life.

However, the above conditions will be corrected when the watch returns to normal temperature.

■ SHOCKS & VIBRATION



Be careful not to drop your watch or hit it against hard surfaces.

■ MAGNETISM



Your watch will be adversely affected by strong magnetism. Keep it away from close contact with magnetic objects.

■ CHEMICALS



Be careful not to expose the watch to solvents, mercury, cosmetic spray, detergents, adhesives or paints. Otherwise, the case, bracelet, etc. may become discolored, deteriorated or damaged.

■ CARE OF CASE AND BRACELET



To prevent possible rusting of the case and bracelet, wipe them periodically with a soft dry cloth.

■ PERIODIC CHECK



It is recommended that the watch be checked once every 2 to 3 years. Have your watch checked by an AUTHORIZED SEIKO DEALER or SERVICE CENTER to ensure that the case, crown, buttons, gasket and crystal seal remain intact.

■ PRECAUTION REGARDING CASE BACK PROTECTIVE FILM



If your watch has a protective film and/or a sticker on the case back, be sure to peel them off before using your watch.

SPECIFICATIONS

- | | | |
|---|---------------------------------------|--|
| 1 | Frequency of crystal oscillator | 32,768 Hz (Hz = Hertz ... Cycles per second) |
| 2 | Loss/gain (monthly rate) | Less than 15 seconds at normal temperature range (5°C ~ 35°C) (41°F ~ 95°F) |
| 3 | Operational temperature range | -10°C ~ +60°C (14°F ~ 140°F) |
| 4 | Driving system | Step motor, 4 pieces |
| 5 | Display system | |
| | "TIME" | TIME mode (hour, minute and second hands) |
| | "ALM.ON" | TIME mode (hour, minute and second hands) |
| | "ALM.SET" | ALARM SETTING mode (hour and minute hands)
The alarm is set on a 12-hour basis. |
| | "TIMER" | TIMER mode (minute and second hands)
Up to 60 minutes can be set in minute increments. |
| | "DATE" | CALENDAR mode (month indicated by the three hands and date displayed in numerals) |
| | "CHRONO." | STOPWATCH mode (minute, second and 1/10 second hands)
The stopwatch can measure up to 60 minutes in 1/10 second increments. |
| 6 | Battery | SEIKO SR927W, 1 piece |
| 7 | IC (Integrated Circuit) | C-MOS-LSI, 1 piece and Bipolar IC, 1 piece |

* The specifications are subject to change without prior notice for product improvement.